

# Rockfon® Curvgrid™

## One-directional System

### Features & Benefits

- Create dramatic arch ceilings, waves, vaults and islands for interior spaces
- Curved and straight main tees connect with perimeter trim without the use of cross tees to form 24" wide ceiling modules
- Fully visible main tees and perimeter trim provide a seamless "ribbon" appearance
- Primary Carrier support for tees and trim requires fewer hanger wires

### Applications

- Assembly Halls
- Auditoriums
- Lobbies
- Schools
- Hospitals



Project – Cushing Middle School in Cushing, OK  
Product – Rockfon® Curvgrid™ One-directional System

# Rockfon® Curvgrid™

## One-directional Curvgrid System

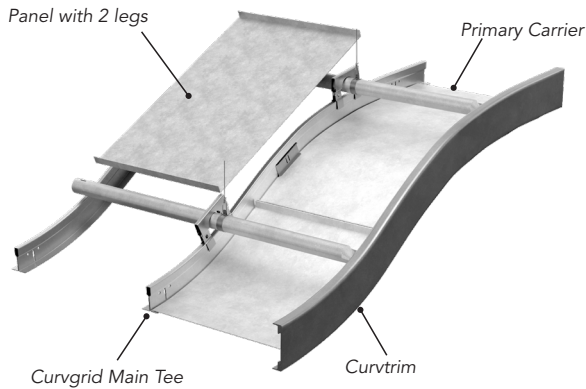

### LEED® v4.1 Highlights

#### Materials and Resources (MR)

- Waste Management Planning ✓
- Interiors Life Cycle Impact Reduction ✓
- Environmental Product Declarations ✓
- Sourcing of Raw Materials ✓
- Material Ingredients -
- Waste Management ✓

#### Indoor Environmental Quality (EQ)

- Low-Emitting Materials ✓
- Interior Lighting -
- Acoustic Performance ✓

Recycled Content: 85% Aluminum  
30% Steel



Family Number & Name	Edge Type	Dimensions		Perforations* (% Open Area)	Material	NRC	Fire Class	Low VOC	Recycled Content
		Width (w)	Length (l)						
252574 (CRVG)	Panel with 1 Leg (COD1)	24"	(w)x48: 48"	Standard <b>SOLID:</b> 0% <b>D:</b> 16.2% <b>E:</b> 20.8% <b>J:</b> 58.2% <b>Q:</b> 70% <b>R:</b> 11.1% <b>V:</b> 4.9% <b>AA:</b> 2.5%  Premium See footnote*  Custom <b>CUST:</b> **	0.032 Aluminum	Up to 0.90	A	Yes	85%
	Panel with 2 Legs (COD2)		(w)x72: 72" (w)x96: 96"						

Product Code Example:

**252574:CRVG:COD1:24x72:.32AL.E.Y**

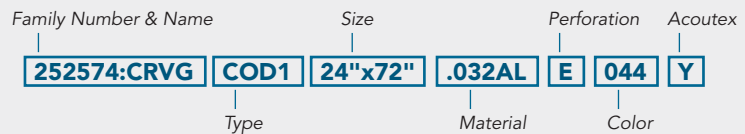

\* See the Rockfon Performance Brochure for graphic representations of the perforations listed and the complete offering of Premium Perforation available.

\*\* For designer specified perforation, contact Rockfon Technical Services at 1-800-323-7164 or techservices@rockfon.com

Note:

- Acoutex™ Backer standard with perforated panel.
- Perforated panel available without Acoutex.
- This system is not approved for exterior use.

# Curvgrid™ Color Chart

## Standard Colors:



01  
White



08  
Black



44  
Satin Silver



888  
Winchester  
Grey

## Premium Colors:



Color  
Chart



RAL  
COLOURS



Custom  
(Color Match)

## Metalwood® Woodgrain Finishes†:



650R  
Maple\*\*



651R  
Cherry\*\*



652R  
Pumpkin  
Maple\*\*



653R  
Oak\*\*



654R  
Karri\*\*



655R  
Bamboo\*\*



656R  
Walnut\*\*



401  
Maple\*



402  
Oak\*



403  
Cherry\*



404  
Pumpkin  
Maple\*



405  
Karri\*



406  
Walnut\*

## Woodscenes® Painted Finishes†:



800  
Lazy Maple



801  
Aged Teak



803  
Burnished  
Cherry



804  
Sleek Cherry



805  
Weathered  
Oak

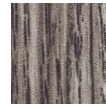

806  
Barnwood  
Grey

\* Coordinating solid color to match Metalwood Woodgrain Finishes.

\*\* Metalwood Woodgrain Finishes not available for Rockfon Curvgrid Suspension, Curvtrim or panels wider than 24"; use coordinating solid color. See footnote\*.

▲ Metalwood Woodgrain Finishes are a 0.008" vinyl laminate that replicate real wood; variations in color and pattern will occur.

For final panel thickness information contact Rockfon Technical Services at 1-800-323-7164 or techservices@rockfon.com. For interior use only.

† Woodscenes Woodgrain Painted Finishes are a decorative powder coat finish that replicate real wood; variations in color and pattern will occur.

### Note:

- Metalwood and Woodscenes grain direction is parallel to the length of the panel.

- See rockfon.com for more information on color options.

Colors shown are reproduced as close as possible to actual product color within the limitations of printing technology. Color chips are available upon request and should be reviewed before making a final selection. Variations in color matches of system components to ceiling panels can result from slight differences in texture, room lighting, painting process and subjectivity of observers.

# Rockfon® Curvgrid™ One-directional System

## Standard Perforation Options

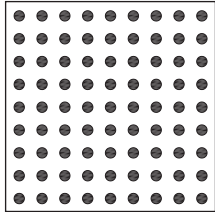

**D**  
**98R216L**  
0.098" Diameter holes  
0.216" Straight centers  
16.2% Open area

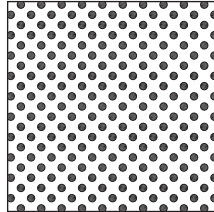

**E**  
**71R138D**  
0.071" Diameter holes  
0.138" Diagonal centers  
20.8% Open area

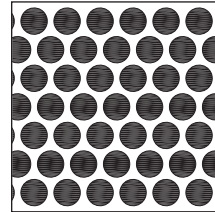

**J**  
**250R312S**  
0.25" Diameter holes  
0.312" Staggered centers  
58.2% Open area

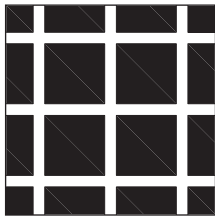

**Q**  
**562S672L**  
0.5625" Square holes  
0.672" Straight centers  
70% Open area

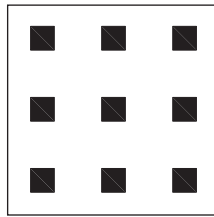

**R**  
**250S750L**  
0.25" Square holes  
0.75" Straight centers  
11.1% Open area

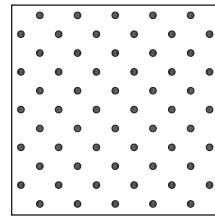

**V**  
**62R250D**  
0.0625" Diameter holes  
0.25" Diagonal centers  
4.9% Open area

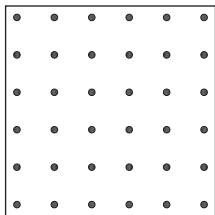

**AA**  
**62R354L**  
0.0625" Diameter holes  
0.354" Straight centers  
2.5% Open area

See the Rockfon® Perforations Brochure for graphic representations of the perforations listed and the complete offering of Premium Perforations available.

## Acoustical Performance

Rockfon Curvgrid System	NRC
NRC - Perforated with Acoutex Backer	0.70
NRC - Perforated with 1-1/2" Acoustical Pad	0.90

# Rockfon® Curvgrid™ One-directional System

## Suspension

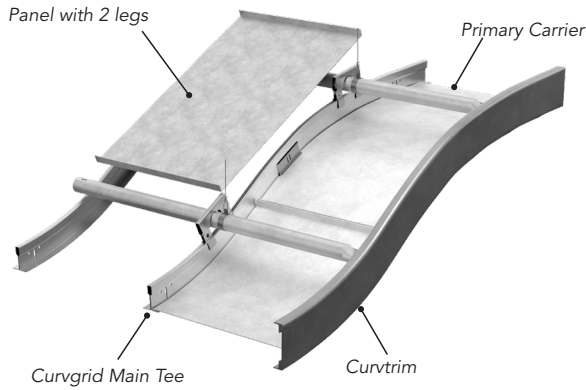

### Suspension Components

Main Runner	Description	Catalog Number	Rockfon Part Number	Length	Height	Recycled Content
	Curved Main Runner Concave*	385.00.xxx	252583	As required per design	1-1/2"	30%
	Curved Main Runner Convex*	385.00.xxx	252583	As required per design	1-1/2"	30%
	Curvgrid Main Runner Straight Sections	385.00.xxx	252583	As required per design	1-1/2"	30%
	Primary Carrier Black	481.024.008	249651	As required per design	1-1/2"	30%



\*Minimum convex and concave suspension radius is 36".

Curvgrid suspension is made to order per the ceiling design. For pricing and ordering information, please contact Estimating at 1-800-323-7164 or [estimating@rockfon.com](mailto:estimating@rockfon.com)

# Rockfon® Curvgrid™ One-directional System

## Perimeter Trim

### Curvtrim Extruded Aluminum Trim - Straight and Curved

Curvtrim Extruded Aluminum Trim	Description	Catalog Number	Rockfon Part Number	Length	Height	Recycled Content
	Curvtrim Straight	290.225.xxx	252584	As required per design	3/4" x 2-1/8" x 3/4"	85%
	Curvtrim Concave Curve*	291.225.xxx	252584	As required per design	3/4" x 2-1/8" x 3/4"	85%
	Curvgrid Convex Curve*	291.225.xxx	252584	As required per design	3/4" x 2-1/8" x 3/4"	85%

\*Minimum convex and concave perimeter trim radius is 36".

Curvtrim Perimeter Trim is made to order per the ceiling design. For pricing and ordering information, please contact Estimating at 1-800-323-7164 or [estimating@rockfon.com](mailto:estimating@rockfon.com)

# Rockfon® Curvgrid™ One-directional System

## Accessory Items

Product	Description	Catalog Number	Rockfon Material Number	Packaging
	Primary Carrier Splice	444.00	249367	Per order
	Primary Carrier Hanger Clip	441.00	250328	Per order
	Clear Hold Down Clip	8886.00	250382	100 pcs per carton
	Panel Clip	445.00	250329	Per order
	Primary Carrier to Curvgrid Clip	442.00	249365	Per order
	Primary Carrier to Curvtrim Clip	443.00	249366	Per order
	Curvgrid Main Tee Splice	436.00	250327	Per order
	Hold Down Insert	437.00	249364	Per order
	Outside Corner Clip	429.00	249360	Per order
	Curvtrim Splice Plate	434.00	249363	Per order
	Grid Attachment Clip	433.00	249362	Per order

# Rockfon® Curvgrid™ One-directional System

## Acoustical Insulation



### Acoustical Pads - Black Vinyl Wrapped

Description	Size	Color	Catalog Number	Rockfon Reference Number
Polywrapped Acoutical Pad 1" x 1#	2' x 2'	Black	58.01.059.008	250505
Polywrapped Acoutical Pad 1" x 1#	2' x 4'	Black	58.01.061.008	250507
Polywrapped Acoutical Pad 1-1/2" x 1#	2' x 2'	Black	58.01.064.008	250509
Polywrapped Acoutical Pad 1-1/2"x 1#	2' x 4'	Black	58.01.063.008	250508

### Acoustical Performance

Rockfon Curvgrid System	NRC
NRC - Perforated with Acoutex Backer	0.70
NRC - Perforated with 1-1/2" Acoustical Pad	0.90





## Rockfon® Curvgrid™ One-directional System Properties

### Material

.032 Aluminum and Galvanized Steel



#### Fire Performance

Surface burning characteristics:  
UL723 (ASTM E84) Flame Spread Index: 0  
Smoke Developed Index (UL Labeled): 0



#### Environment

Recycled content:  
85% Aluminum  
30% Steel  
100% locally recyclable



#### Warranty

1-Year Limited Product Warranty  
See [rockfon.com](http://rockfon.com)



#### Hygiene

Metal provides no sustenance  
to microorganisms



#### Cleaning

Damp cloth

031122

### Rockfon

4849 S. Austin Ave.  
Chicago, IL 60638 USA